

Article number: 12709000040120

Description: KLEE-coil 709 000 040.120
M4 Unhardened, zinc-pl. & chr. yellow

Measures

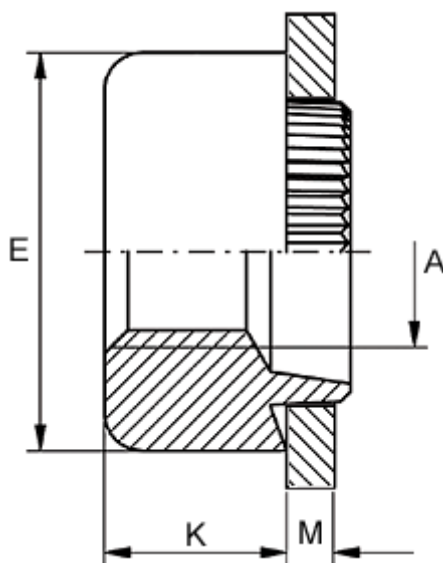

Female thread A	= M4
Height K	= 4.0
Outer diameter E	= 10.0
Plate thickness	= 2.3 to 2.5
Recommended bore diameter for extreme load	= 7.0
Recommended bore diameter for normal use	= 7.0